

# LM6142 and LM6144

## 17 MHz Rail-to-Rail Input-Output Operational Amplifiers

### General Description

Using patent pending new circuit topologies, the LM6142/44 provides new levels of performance in applications where low voltage supplies or power limitations previously made compromise necessary. Operating on supplies of 1.8V to over 24V, the LM6142/44 is an excellent choice for battery operated systems, portable instrumentation and others.

The greater than rail-to-rail input voltage range eliminates concern over exceeding the common-mode voltage range. The rail-to-rail output swing provides the maximum possible dynamic range at the output. This is particularly important when operating on low supply voltages.

High gain-bandwidth with 650  $\mu$ A/Amplifier supply current opens new battery powered applications where previous higher power consumption reduced battery life to unacceptable levels. The ability to drive large capacitive loads without oscillating functionally removes this common problem.

### Features

At  $V_S = 5V$ . Typ unless noted.

- Rail-to-rail input CMVR  $-0.25V$  to  $5.25V$
- Rail-to-rail output swing  $0.005V$  to  $4.995V$
- Wide gain-bandwidth: 17 MHz at 50 kHz (typ)
- Slew rate:
  - Small signal,  $5V/\mu s$
  - Large signal,  $30V/\mu s$
- Low supply current 650  $\mu$ A/Amplifier
- Wide supply range 1.8V to 24V
- CMRR 107 dB
- Gain 108 dB with  $R_L = 10k$
- PSRR 87 dB

### Applications

- Battery operated instrumentation
- Depth sounders/fish finders
- Barcode scanners
- Wireless communications
- Rail-to-rail in-out instrumentation amps

### Connection Diagrams

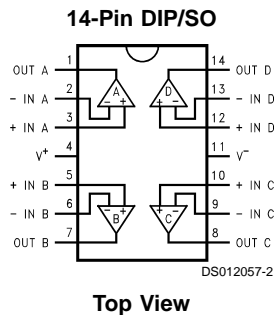
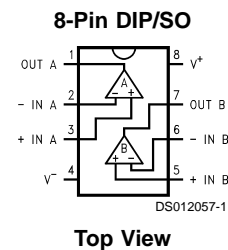
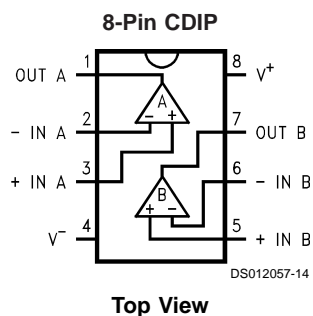

**Absolute Maximum Ratings** (Note 1)

If Military/Aerospace specified devices are required, please contact the National Semiconductor Sales Office/Distributors for availability and specifications.

ESD Tolerance (Note 2)	2500V
Differential Input Voltage	15V
Voltage at Input/Output Pin	(V+) + 0.3V, (V-) – 0.3V
Supply Voltage (V+ – V-)	35V
Current at Input Pin	±10 mA
Current at Output Pin (Note 3)	±25 mA
Current at Power Supply Pin	50 mA
Lead Temperature (soldering, 10 sec)	260°C

Storage Temp. Range	–65°C to +150°C
Junction Temperature (Note 4)	150°C

**Operating Ratings** (Note 1)

Supply Voltage	1.8V ≤ V+ ≤ 24V
Junction Temperature Range	–40°C ≤ T <sub>J</sub> ≤ +85°C
LM6142, LM6144	
Thermal Resistance (θ <sub>JA</sub> )	
N Package, 8-Pin Molded DIP	115°C/W
M Package, 8-Pin Surface Mount	193°C/W
N Package, 14-Pin Molded DIP	81°C/W
M Package, 14-Pin Surface Mount	126°C/W

**5.0V DC Electrical Characteristics**

Unless otherwise specified, all limits guaranteed for T<sub>J</sub> = 25°C, V+ = 5.0V, V- = 0V, V<sub>CM</sub> = V<sub>O</sub> = V+/2 and R<sub>L</sub> > 1 MΩ or V+/2. **Boldface limits** apply at the temperature extremes.

Symbol	Parameter	Conditions	Typ (Note 5)	LM6144AI LM6142AI Limit (Note 6)	LM6144BI LM6142BI Limit (Note 6)	Units
V <sub>OS</sub>	Input Offset Voltage		0.3	1.0 <b>2.2</b>	2.5 <b>3.3</b>	mV max
TCV <sub>OS</sub>	Input Offset Voltage Average Drift		<b>3</b>			µV/°C
I <sub>B</sub>	Input Bias Current		170	250	300	nA max
		0V ≤ V <sub>CM</sub> ≤ 5V	180	280 <b>526</b>	<b>526</b>	
I <sub>OS</sub>	Input Offset Current		3	30 <b>80</b>	30 <b>80</b>	nA max
R <sub>IN</sub>	Input Resistance, C <sub>M</sub>		126			MΩ
CMRR	Common Mode Rejection Ratio	0V ≤ V <sub>CM</sub> ≤ 4V	107	84 <b>78</b>	84 <b>78</b>	dB min
		0V ≤ V <sub>CM</sub> ≤ 5V	82 <b>79</b>	66 <b>64</b>	66 <b>64</b>	
PSRR	Power Supply Rejection Ratio	5V ≤ V+ ≤ 24V	<b>87</b>	80 <b>78</b>	80 <b>78</b>	
V <sub>CM</sub>	Input Common-Mode Voltage Range		–0.25 5.25	<b>0</b> <b>5.0</b>	<b>0</b> <b>5.0</b>	V
A <sub>V</sub>	Large Signal Voltage Gain	R <sub>L</sub> = 10k	270 <b>70</b>	100 <b>33</b>	80 <b>25</b>	V/mV min
V <sub>O</sub>	Output Swing	R <sub>L</sub> = 100k	0.005	0.01 <b>0.013</b>	0.01 <b>0.013</b>	V max
			4.995	4.98 <b>4.93</b>	4.98 <b>4.93</b>	V min
		R <sub>L</sub> = 10k	0.02			V max
			4.97			V min
		R <sub>L</sub> = 2k	0.06	0.1 <b>0.133</b>	0.1 <b>0.133</b>	V max
			4.90	4.86 <b>4.80</b>	4.86 <b>4.80</b>	V min

## 5.0V DC Electrical Characteristics (Continued)

Unless otherwise specified, all limits guaranteed for  $T_J = 25^\circ\text{C}$ ,  $V_+ = 5.0\text{V}$ ,  $V_- = 0\text{V}$ ,  $V_{CM} = V_O = V_+/2$  and  $R_L > 1\text{M}\Omega$  to  $V_+/2$ . **Boldface limits** apply at the temperature extremes.

Symbol	Parameter	Conditions	Typ (Note 5)	LM6144AI LM6142AI Limit (Note 6)	LM6144BI LM6142BI Limit (Note 6)	Units
$I_{SC}$	Output Short Circuit Current LM6142	Sourcing	13	10	8	mA
				<b>4.9</b>	<b>4</b>	
		Sinking	24	10	10	mA
				<b>5.3</b>	<b>5.3</b>	
$I_{SC}$	Output Short Circuit Current LM6144	Sourcing	8	6	6	mA
				<b>3</b>	<b>3</b>	
		Sinking	22	8	8	mA
				<b>4</b>	<b>4</b>	
$I_S$	Supply Current	Per Amplifier	650	800	800	$\mu\text{A}$
				<b>880</b>	<b>880</b>	

## 5.0V AC Electrical Characteristics

Unless Otherwise Specified, All Limits Guaranteed for  $T_J = 25^\circ\text{C}$ ,  $V_+ = 5.0\text{V}$ ,  $V_- = 0\text{V}$ ,  $V_{CM} = V_O = V_+/2$  and  $R_L > 1\text{M}\Omega$  to  $V_+/2$ . **Boldface limits** apply at the temperature extremes.

Symbol	Parameter	Conditions	Typ (Note 5)	LM6144AI LM6142AI Limit (Note 6)	LM6144BI LM6142BI Limit (Note 6)	Units
SR	Slew Rate	$8 V_{p-p} @ V_{CC} 12\text{V}$ $R_S > 1\text{k}\Omega$	25	15 <b>13</b>	13 <b>11</b>	$\text{V}/\mu\text{s}$ min
GBW	Gain-Bandwidth Product	$f = 50\text{kHz}$	17	10 <b>6</b>	10 <b>6</b>	MHz min
$\phi_m$	Phase Margin		38			Deg
	Amp-to-Amp Isolation		130			dB
$e_n$	Input-Referred Voltage Noise	$f = 1\text{kHz}$	16			$\frac{\text{nV}}{\sqrt{\text{Hz}}}$
$i_n$	Input-Referred Current Noise	$f = 1\text{kHz}$	0.22			$\frac{\text{pA}}{\sqrt{\text{Hz}}}$
T.H.D.	Total Harmonic Distortion	$f = 10\text{kHz}$ , $R_L = 10\text{k}\Omega$ ,	0.003			%

## 2.7V DC Electrical Characteristics

Unless Otherwise Specified, All Limits Guaranteed for  $T_J = 25^\circ\text{C}$ ,  $V_+ = 2.7\text{V}$ ,  $V_- = 0\text{V}$ ,  $V_{\text{CM}} = V_O = V_+/2$  and  $R_L > 1\text{ M}\Omega$  to  $V_+/2$ . **Boldface** limits apply at the temperature extreme

Symbol	Parameter	Conditions	Typ (Note 5)	LM6144AI LM6142AI Limit (Note 6)	LM6144BI LM6142BI Limit (Note 6)	Units
$V_{\text{OS}}$	Input Offset Voltage		0.4	1.8 <b>4.3</b>	2.5 <b>5</b>	mV max
$I_B$	Input Bias Current		150	250 <b>526</b>	300 <b>526</b>	nA max
$I_{\text{OS}}$	Input Offset Current		4	30 <b>80</b>	30 <b>80</b>	nA max
$R_{\text{IN}}$	Input Resistance		128			$\text{M}\Omega$
CMRR	Common Mode Rejection Ratio	$0\text{V} \leq V_{\text{CM}} \leq 1.8\text{V}$	90			dB min
		$0\text{V} \leq V_{\text{CM}} \leq 2.7\text{V}$	76			
PSRR	Power Supply Rejection Ratio	$3\text{V} \leq V_+ \leq 5\text{V}$	79			
$V_{\text{CM}}$	Input Common-Mode Voltage Range		-0.25	0	0	V min
			2.95	2.7	2.7	V max
$A_V$	Large Signal Voltage Gain	$R_L = 10\text{k}$	55			V/mV min
$V_O$	Output Swing	$R_L = 100\text{k}\Omega$	0.019	0.08 <b>0.112</b>	0.08 <b>0.112</b>	V max
			2.67	2.66 <b>2.25</b>	2.66 <b>2.25</b>	V min
$I_S$	Supply Current	Per Amplifier	510	800 <b>880</b>	800 <b>880</b>	$\mu\text{A}$ max

## 2.7V AC Electrical Characteristics

Unless Otherwise Specified, All Limits Guaranteed for  $T_J = 25^\circ\text{C}$ ,  $V_+ = 2.7\text{V}$ ,  $V_- = 0\text{V}$ ,  $V_{\text{CM}} = V_O = V_+/2$  and  $R_L > 1\text{ M}\Omega$  to  $V_+/2$ . **Boldface** limits apply at the temperature extreme

Symbol	Parameter	Conditions	Typ (Note 5)	LM6144AI LM6142AI Limit (Note 6)	LM6144BI LM6142BI Limit (Note 6)	Units
GBW	Gain-Bandwidth Product	$f = 50\text{ kHz}$	9			MHz
$\phi_m$	Phase Margin		36			Deg
$G_m$	Gain Margin		6			dB

## 24V Electrical Characteristics

Unless Otherwise Specified, All Limits Guaranteed for  $T_J = 25^\circ\text{C}$ ,  $V_+ = 24\text{V}$ ,  $V_- = 0\text{V}$ ,  $V_{\text{CM}} = V_O = V_+/2$  and  $R_L > 1\text{ M}\Omega$  to  $V_S/2$ . **Boldface** limits apply at the temperature extreme

Symbol	Parameter	Conditions	Typ (Note 5)	LM6144AI LM6142AI Limit (Note 6)	LM6144BI LM6142BI Limit (Note 6)	Units
$V_{\text{OS}}$	Input Offset Voltage		1.3	2 <b>4.8</b>	3.8 <b>4.8</b>	mV max
$I_B$	Input Bias Current		174			nA max
$I_{\text{OS}}$	Input Offset Current		5			nA max
$R_{\text{IN}}$	Input Resistance		288			M $\Omega$
CMRR	Common Mode Rejection Ratio	$0\text{V} \leq V_{\text{CM}} \leq 23\text{V}$	114			dB min
		$0\text{V} \leq V_{\text{CM}} \leq 24\text{V}$	100			
PSRR	Power Supply Rejection Ratio	$0\text{V} \leq V_{\text{CM}} \leq 24\text{V}$	87			
$V_{\text{CM}}$	Input Common-Mode Voltage Range		-0.25	0	0	V min
			24.25	24	24	V max
$A_V$	Large Signal Voltage Gain	$R_L = 10\text{k}$	500			V/mV min
$V_O$	Output Swing	$R_L = 10\text{ k}\Omega$	0.07	0.15 <b>0.185</b>	0.15 <b>0.185</b>	V max
			23.85	23.81 <b>23.62</b>	23.81 <b>23.62</b>	V min
$I_S$	Supply Current	Per Amplifier	750	1100 <b>1150</b>	1100 <b>1150</b>	$\mu\text{A}$ max
GBW	Gain-Bandwidth Product	$f = 50\text{ kHz}$	18			MHz

**Note 1:** Absolute Maximum Ratings indicate limits beyond which damage to the device may occur. Operating Ratings indicate conditions for which the device is intended to be functional, but specific performance is not guaranteed. For guaranteed specifications and the test conditions, see the Electrical Characteristics.

**Note 2:** Human body model, 1.5 k $\Omega$  in series with 100 pF.

**Note 3:** Applies to both single-supply and split-supply operation. Continuous short circuit operation at elevated ambient temperature can result in exceeding the maximum allowed junction temperature of 150°C.

**Note 4:** The maximum power dissipation is a function of  $T_{J(\text{max})}$ ,  $\theta_{\text{JA}}$ , and  $T_A$ . The maximum allowable power dissipation at any ambient temperature is  $P_D = (T_{J(\text{max})} - T_A)/\theta_{\text{JA}}$ . All numbers apply for packages soldered directly into a PC board.

**Note 5:** Typical values represent the most likely parametric norm.

**Note 6:** All limits are guaranteed by testing or statistical analysis.

**Note 7:** For guaranteed military specifications see military datasheet MNL6142AM-X.

**Typical Performance Characteristics**  $T_A = 25^\circ\text{C}$ ,  $R_L = 10\text{ k}\Omega$  Unless Otherwise Specified

**Supply Current vs Supply Voltage**

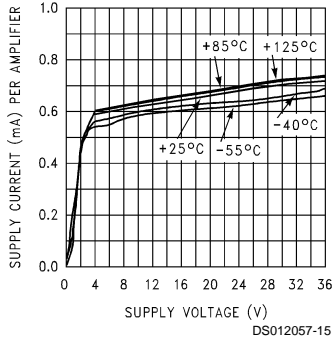

**Offset Voltage vs Supply Voltage**

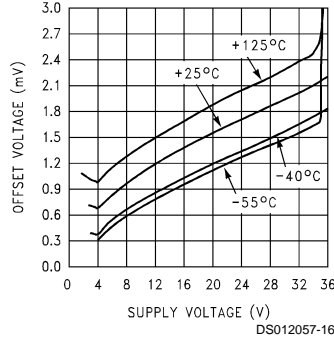

**Bias Current vs Supply Voltage**

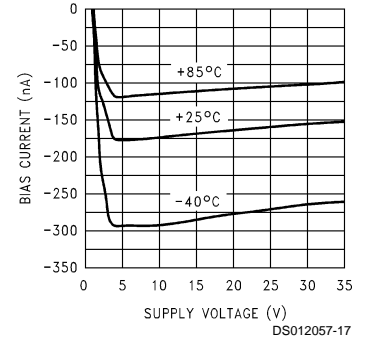

**Offset Voltage vs  $V_{CM}$**

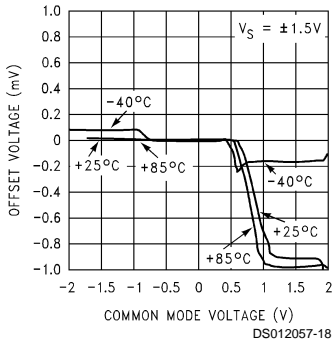

**Offset Voltage vs  $V_{CM}$**

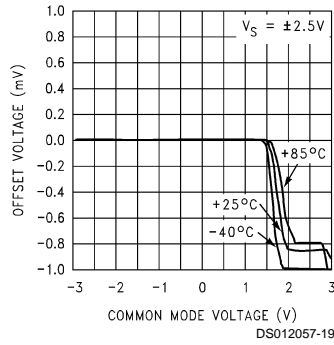

**Offset Voltage vs  $V_{CM}$**

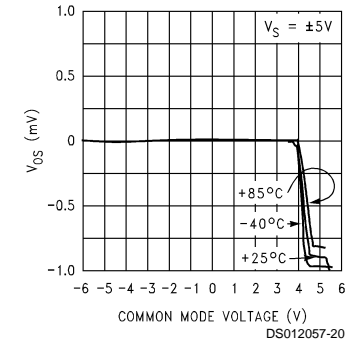

**Bias Current vs  $V_{CM}$**

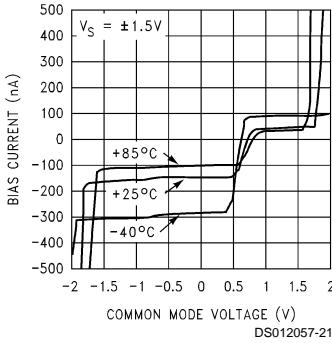

**Bias Current vs  $V_{CM}$**

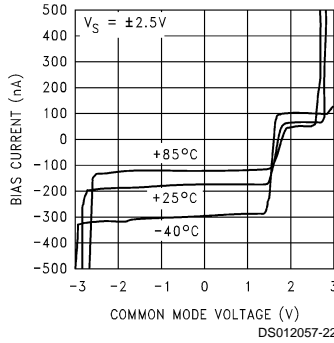

**Bias Current vs  $V_{CM}$**

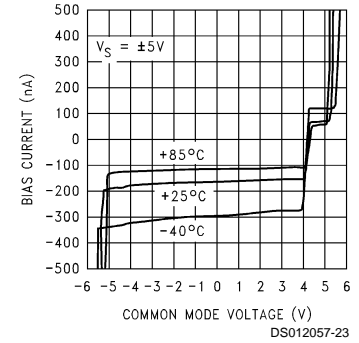

**Open-Loop Transfer Function**

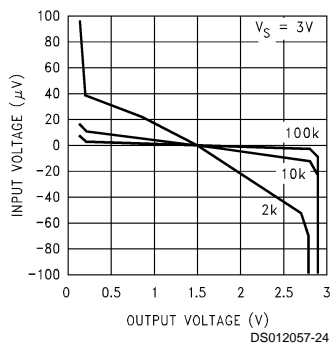

**Open-Loop Transfer Function**

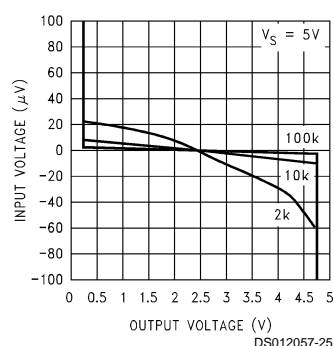

**Open-Loop Transfer Function**

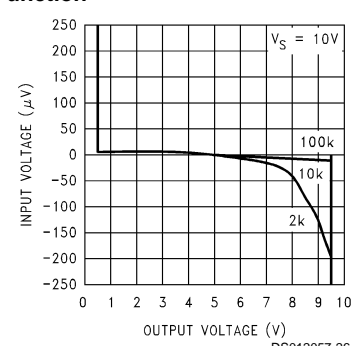

# Typical Performance Characteristics $T_A = 25^\circ\text{C}$ , $R_L = 10\text{ k}\Omega$ Unless Otherwise Specified (Continued)

**Output Voltage vs Source Current**

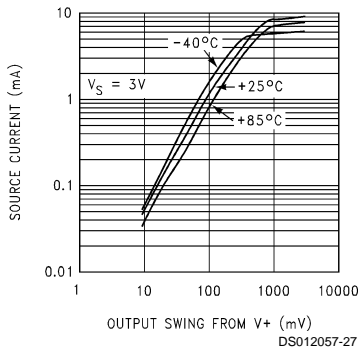

**Output Voltage vs Source Current**

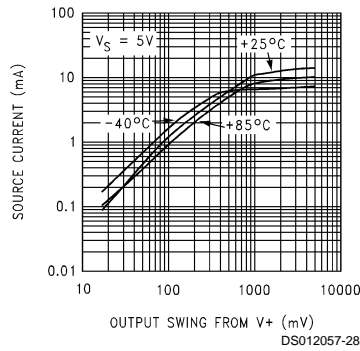

**Output Voltage vs Source Current**

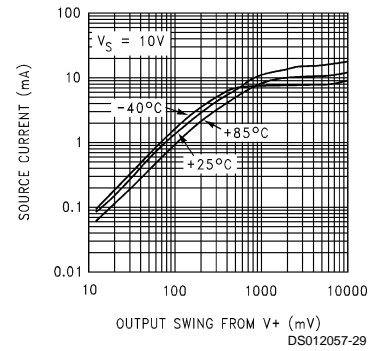

**Output Voltage vs Sink Current**

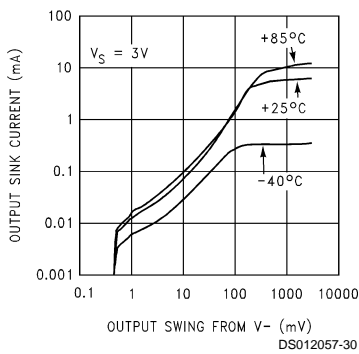

**Output Voltage vs Sink Current**

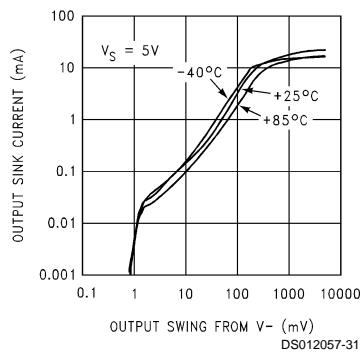

**Output Voltage vs Sink Current**

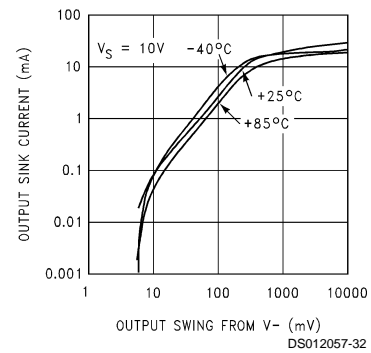

**Gain and Phase vs Load**

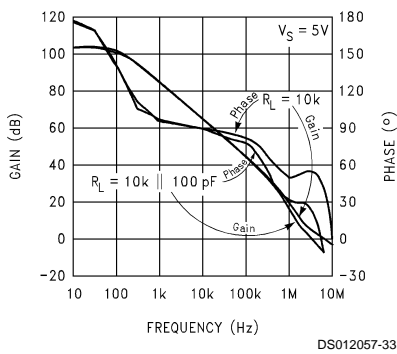

**Gain and Phase vs Load**

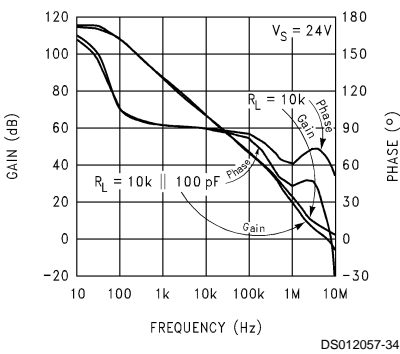

**Distortion + Noise vs Frequency**

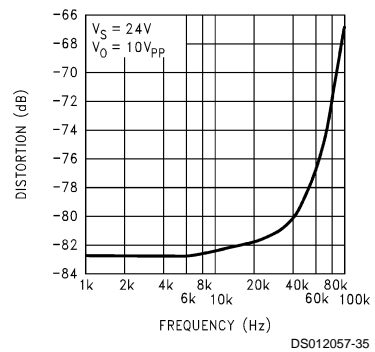

# Typical Performance Characteristics $T_A = 25^\circ\text{C}$ , $R_L = 10\text{ k}\Omega$ Unless Otherwise Specified (Continued)

Specified (Continued)

**GBW vs Supply**

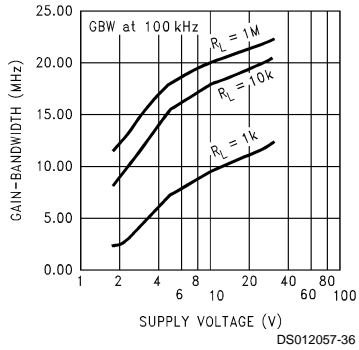

**Open Loop Gain vs Load, 3V Supply**

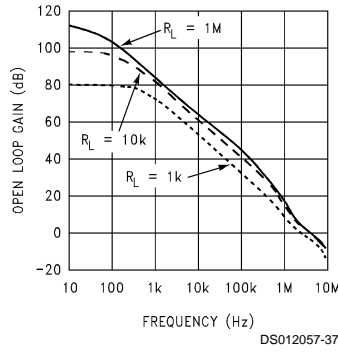

**Open Loop Gain vs Load, 5V Supply**

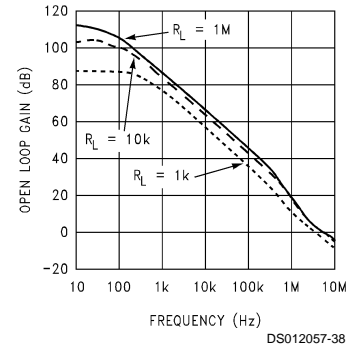

**Open Loop Gain vs Load, 24V Supply**

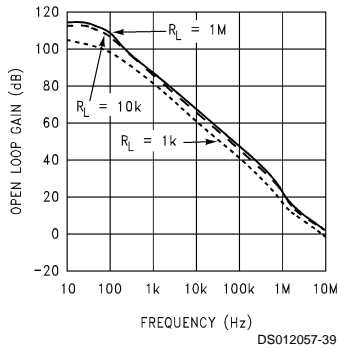

**Unity Gain Freq vs  $V_S$**

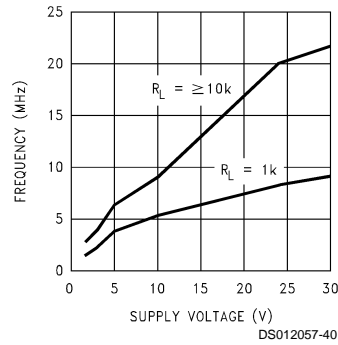

**CMRR vs Frequency**

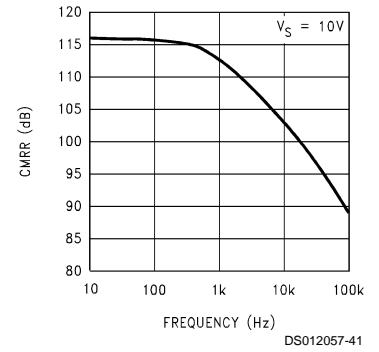

**Crosstalk vs Frequency**

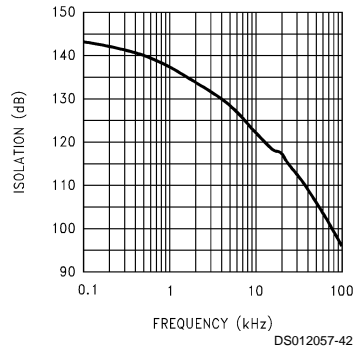

**PSRR vs Frequency**

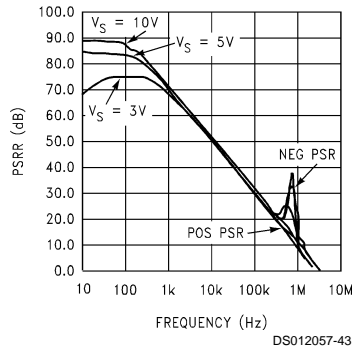

**Noise Voltage vs Frequency**

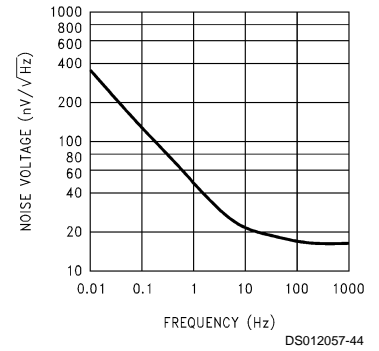



## Typical Performance Characteristics $T_A = 25^\circ\text{C}$ , $R_L = 10\text{ k}\Omega$ Unless Otherwise Specified (Continued)

### Noise Current vs Frequency

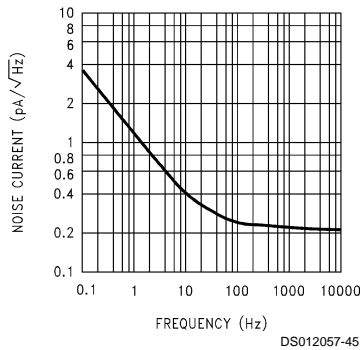

### NE vs R Source

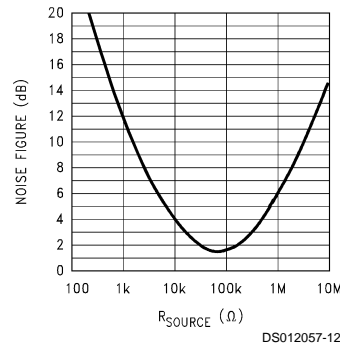

## LM6142/44 Application Ideas

The LM6142 brings a new level of ease of use to opamp system design.

With greater than rail-to-rail input voltage range concern over exceeding the common-mode voltage range is eliminated.

Rail-to-rail output swing provides the maximum possible dynamic range at the output. This is particularly important when operating on low supply voltages.

The high gain-bandwidth with low supply current opens new battery powered applications, where high power consumption, previously reduced battery life to unacceptable levels.

To take advantage of these features, some ideas should be kept in mind.

### ENHANCED SLEW RATE

Unlike most bipolar opamps, the unique phase reversal prevention/speed-up circuit in the input stage causes the slew rate to be very much a function of the input signal amplitude.

Figure 2 shows how excess input signal, is routed around the input collector-base junctions, directly to the current mirrors.

The LM6142/44 input stage converts the input voltage change to a current change. This current change drives the current mirrors through the collectors of Q1–Q2, Q3–Q4 when the input levels are normal.

If the input signal exceeds the slew rate of the input stage, the differential input voltage rises above two diode drops. This excess signal bypasses the normal input transistors, (Q1–Q4), and is routed in correct phase through the two additional transistors, (Q5, Q6), directly into the current mirrors.

This rerouting of excess signal allows the slew-rate to increase by a factor of 10 to 1 or more. (See Figure 1.)

As the overdrive increases, the opamp reacts better than a conventional opamp. Large fast pulses will raise the slew-rate to around 30V to 60V/μs.

### Slew Rate vs $\Delta V_{IN}$ $V_S = \pm 5V$

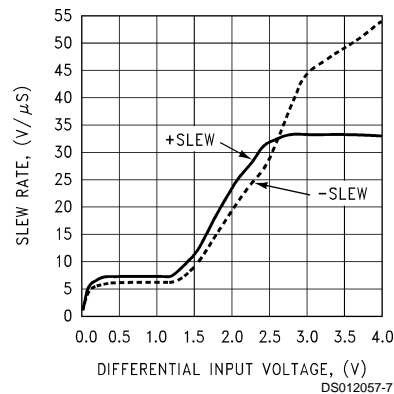

FIGURE 1.

This effect is most noticeable at higher supply voltages and lower gains where incoming signals are likely to be large.

This new input circuit also eliminates the phase reversal seen in many opamps when they are overdriven.

This speed-up action adds stability to the system when driving large capacitive loads.

### DRIVING CAPACITIVE LOADS

Capacitive loads decrease the phase margin of all opamps. This is caused by the output resistance of the amplifier and the load capacitance forming an R-C phase lag network. This can lead to overshoot, ringing and oscillation. Slew rate limiting can also cause additional lag. Most opamps with a fixed maximum slew-rate will lag further and further behind when driving capacitive loads even though the differential input voltage raises. With the LM6142, the lag causes the slew rate to raise. The increased slew-rate keeps the output following the input much better. This effectively reduces phase lag. After the output has caught up with the input, the differential input voltage drops down and the amplifier settles rapidly.

## LM6142/44 Application Ideas (Continued)

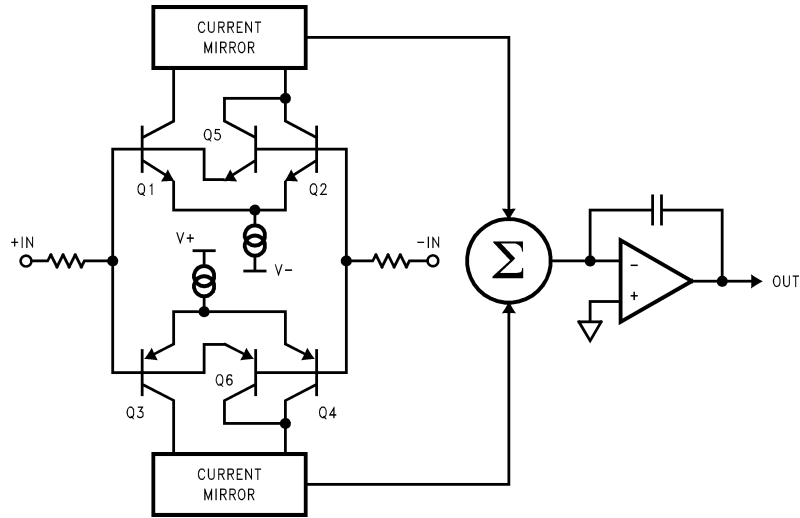

DS012057-6

FIGURE 2.

These features allow the LM6142 to drive capacitive loads as large as 1000 pF at unity gain and not oscillate. The scope photos (Figure 3 and Figure 4) above show the LM6142 driving a 1000 pF load. In Figure 3, the upper trace is with no capacitive load and the lower trace is with a 1000 pF load. Here we are operating on  $\pm 12V$  supplies with a 20 Vp-p pulse. Excellent response is obtained with a  $C_f$  of 10 pF. In Figure 4, the supplies have been reduced to  $\pm 2.5V$ , the pulse is 4 Vp-p and  $C_f$  is 39 pF. The best value for the compensation capacitor is best established after the board layout is finished because the value is dependent on board stray capacity, the value of the feedback resistor, the closed loop gain and, to some extent, the supply voltage.

Another effect that is common to all opamps is the phase shift caused by the feedback resistor and the input capacitance. This phase shift also reduces phase margin. This effect is taken care of at the same time as the effect of the capacitive load when the capacitor is placed across the feedback resistor.

The circuit shown in Figure 5 was used for these scope photos.

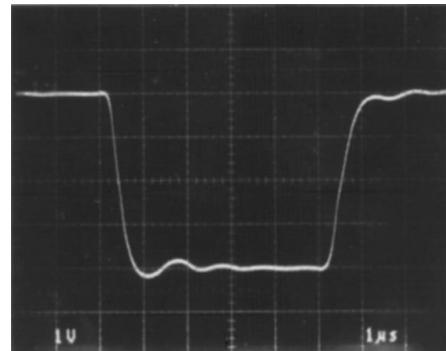

DS012057-9

FIGURE 4.

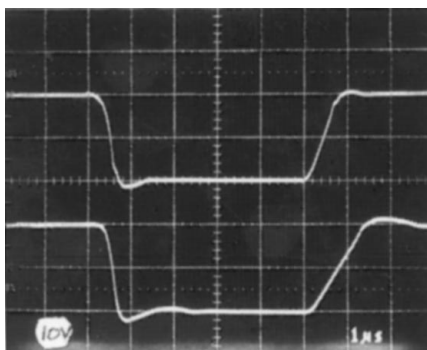

DS012057-8

FIGURE 3.

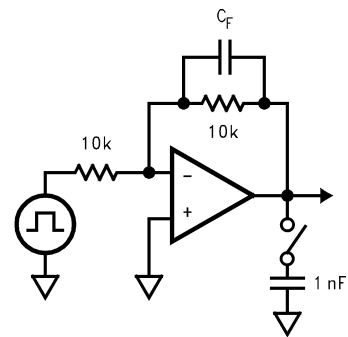

DS012057-10

FIGURE 5.

## Typical Applications

### FISH FINDER/ DEPTH SOUNDER.

The LM6142/44 is an excellent choice for battery operated fish finders. The low supply current, high gain-bandwidth and full rail to rail output swing of the LM6142 provides an ideal combination for use in this and similar applications.

## Typical Applications (Continued)

### ANALOG TO DIGITAL CONVERTER BUFFER

The high capacitive load driving ability, rail-to-rail input and output range with the excellent CMR of 82 dB, make the LM6142/44 a good choice for buffering the inputs of A to D converters.

### 3 OPAMP INSTRUMENTATION AMP WITH RAIL-TO-RAIL INPUT AND OUTPUT

Using the LM6144, a 3 opamp instrumentation amplifier with rail-to-rail inputs and rail to rail output can be made. These features make these instrumentation amplifiers ideal for single supply systems.

Some manufacturers use a precision voltage divider array of 5 resistors to divide the common-mode voltage to get an input range of rail-to-rail or greater. The problem with this method is that it also divides the signal, so to even get unity gain, the amplifier must be run at high closed loop gains. This raises the noise and drift by the internal gain factor and lowers the input impedance. Any mismatch in these precision resistors reduces the CMR as well. Using the LM6144, all of these problems are eliminated.

In this example, amplifiers A and B act as buffers to the differential stage (*Figure 6*). These buffers assure that the input impedance is over 100 M $\Omega$  and they eliminate the requirement for precision matched resistors in the input stage. They also assure that the difference amp is driven from a voltage source. This is necessary to maintain the CMR set by the matching of R1–R2 with R3–R4.

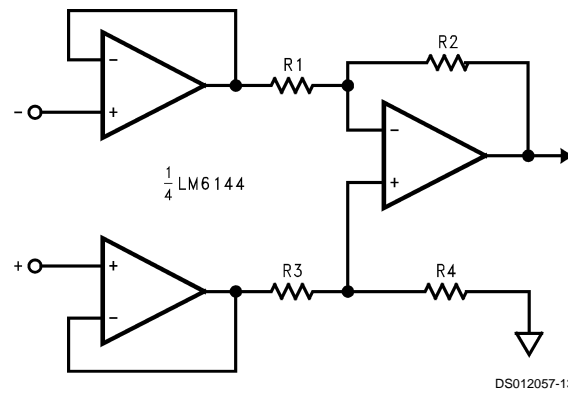

FIGURE 6.

The gain is set by the ratio of R2/R1 and R3 should equal R1 and R4 equal R2. Making R4 slightly smaller than R2 and adding a trim pot equal to twice the difference between R2 and R4 will allow the CMR to be adjusted for optimum.

With both rail to rail input and output ranges, the inputs and outputs are only limited by the supply voltages. Remember that even with rail-to-rail output, the output can not swing past the supplies so the combined common mode voltage plus the signal should not be greater than the supplies or limiting will occur.

### SPICE MACROMODEL

A SPICE macromodel of this and many other National Semiconductor opamps is available at no charge from the NSC Customer Response Group at 800-272-9959.

## Ordering Information

Package	Temperature Range	Temperature Range	NSC Drawing
	Industrial –40°C to +85°C	Military –55°C to +125°C	
8-Pin Molded DIP	LM6142AIN, LM6142BIN		N08E
8-Pin Small Outline LM6142AIMX, LM6142BIM, LM6142BIMX, LM6142BIMTX,	LM6142AIM, LM6142BIM, LM6142BIMX, LM6142BIMTX,		M08A
14-Pin Molded DIP	LM6144AIN, LM6144BIN		N14A
14-Pin Small Outline LM6144AIMX, LM6144BIM, LM6144BIMX	LM6144AIM, LM6144BIM, LM6144BIMX		M14A
8-Pin CDIP	LM6142AMJ-QML		J08A

**Physical Dimensions** inches (millimeters) unless otherwise noted

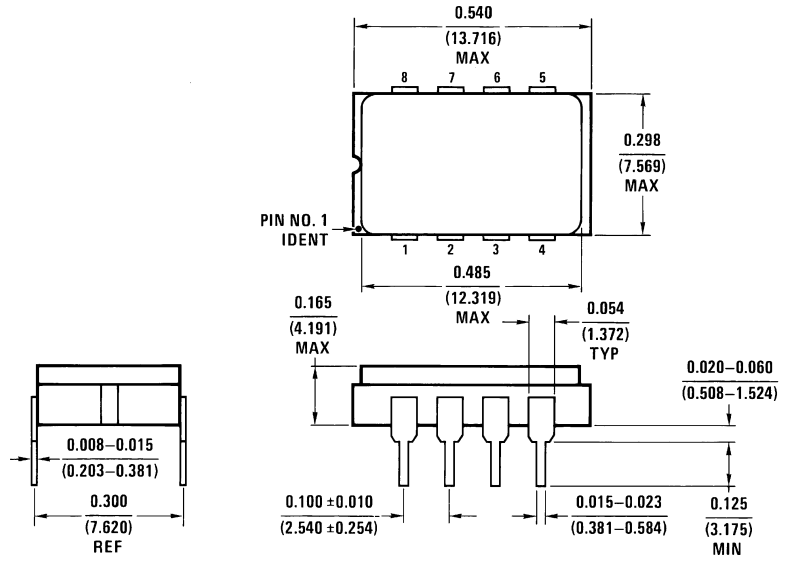

D08C (REV C)

**8-Pin Ceramic Sidebraced  
Dual-In-Line Package**  
Order Number LM6142AMJ-QML  
NS Package Number D08C

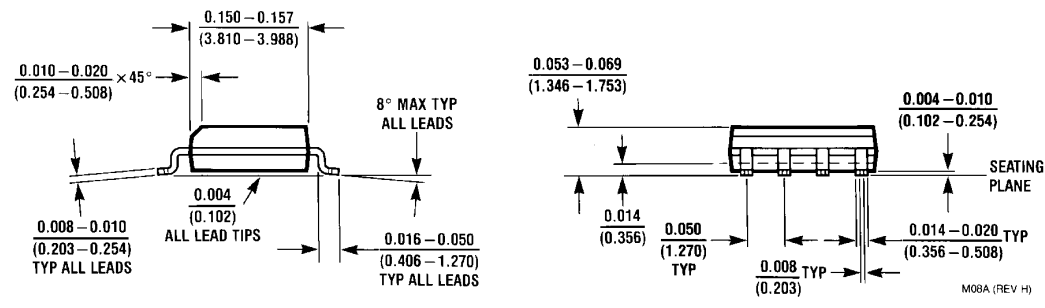
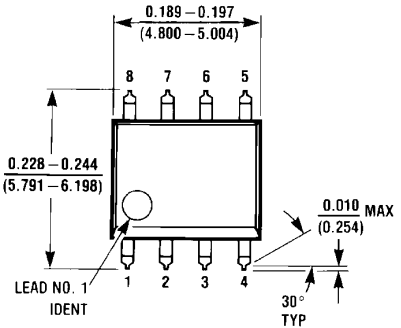

M08A (REV H)

**8-Pin Small Outline Package**  
Order Number LM6142AIM, LM6142AIMX or LM6142BIM, LM6142BIMX  
NS Package Number M08A

**Physical Dimensions** inches (millimeters) unless otherwise noted (Continued)

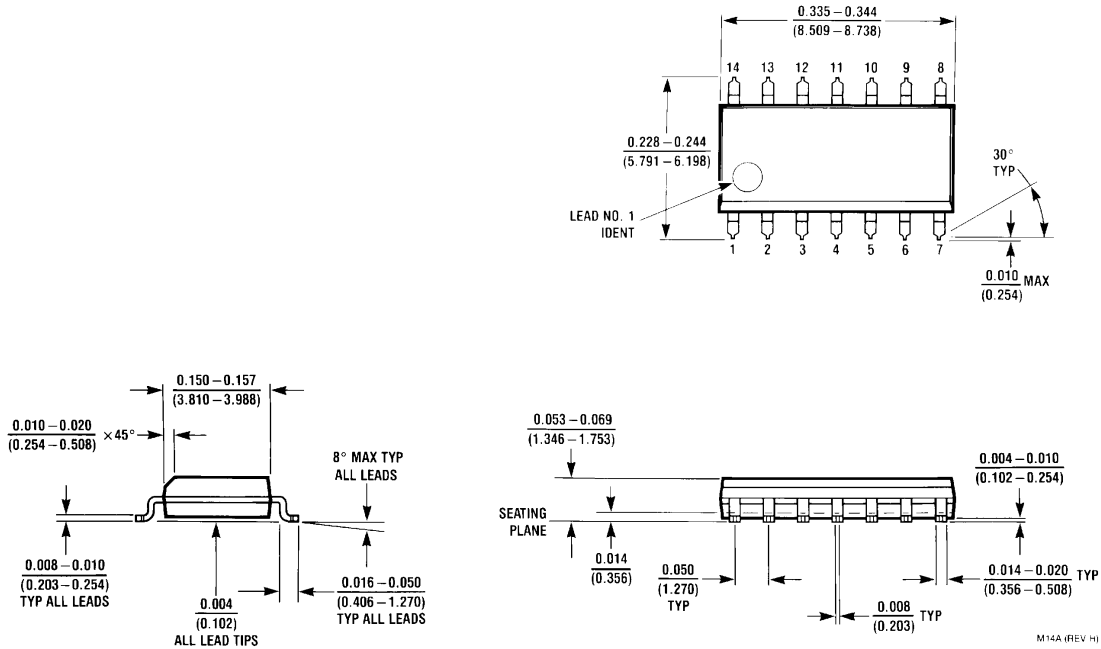

**14-Pin Small Outline Package**  
**Order Number LM6144AIM, LM6144AIMX or LM6144BIM, LM6144BIMX**  
**NS Package Number M14A**

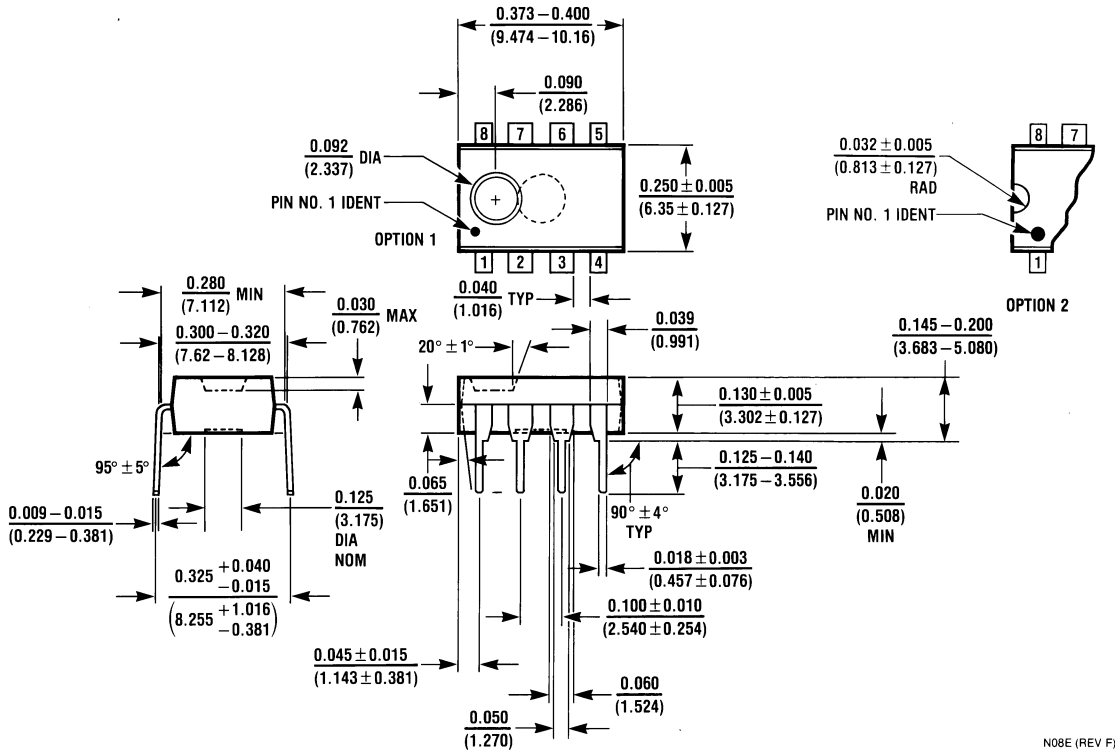

**8-Pin Molded Dual-In-Line Package**  
**Order Number LM6142AIN, LM6142BIN, LM6142BIMT or LM6142BIMTX**  
**NS Package Number N08E**

**Physical Dimensions** inches (millimeters) unless otherwise noted (Continued)

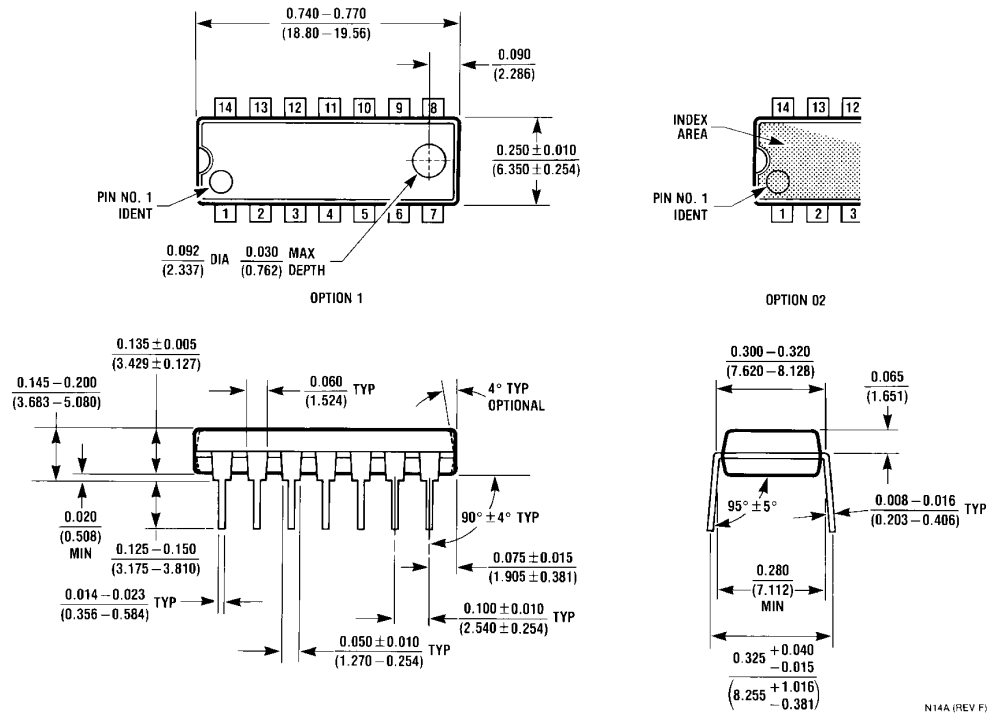

**14-Pin Molded Dual-In-Line Package**  
**Order Number LM6144AIN or LM6144BIN**  
**NS Package Number N14A**

N14A (REV F)

**LIFE SUPPORT POLICY**

NATIONAL'S PRODUCTS ARE NOT AUTHORIZED FOR USE AS CRITICAL COMPONENTS IN LIFE SUPPORT DEVICES OR SYSTEMS WITHOUT THE EXPRESS WRITTEN APPROVAL OF THE PRESIDENT AND GENERAL COUNSEL OF NATIONAL SEMICONDUCTOR CORPORATION. As used herein:

1. Life support devices or systems are devices or systems which, (a) are intended for surgical implant into the body, or (b) support or sustain life, and whose failure to perform when properly used in accordance with instructions for use provided in the labeling, can be reasonably expected to result in a significant injury to the user.
2. A critical component is any component of a life support device or system whose failure to perform can be reasonably expected to cause the failure of the life support device or system, or to affect its safety or effectiveness.

 **National Semiconductor Corporation**  
Americas  
Tel: 1-800-272-9959  
Fax: 1-800-737-7018  
Email: support@nsc.com  
www.national.com

**National Semiconductor Europe**  
Fax: +49 (0) 180-530 85 86  
Email: europe.support@nsc.com  
Deutsch Tel: +49 (0) 69 9508 6208  
English Tel: +44 (0) 870 24 0 2171  
Français Tel: +33 (0) 1 41 91 8790

**National Semiconductor Asia Pacific Customer Response Group**  
Tel: 65-2544466  
Fax: 65-2504466  
Email: ap.support@nsc.com

**National Semiconductor Japan Ltd.**  
Tel: 81-3-5639-7560  
Fax: 81-3-5639-7507